

BUILDING
COMMON GROUND



Resumen de productos y servicios

MAX FRANK Group



BUILDING COMMON GROUND

Las soluciones de proyectos individuales y la gama de productos del Grupo MAX FRANK son reconocidos internacionalmente y se encuentran en los más diversos tipos de estructuras, como edificios de gran altura, puentes, túneles o infraestructuras. Desde su inicio, MAX FRANK se ha convertido en un proveedor especializado de tecnología de la construcción. Colaboramos con nuestros clientes en todas las fases de la construcción gracias a nuestra experiencia, a una herramienta industrial puntera, productos de alta calidad y servicios multifacéticos. El valor añadido se genera para nuestros socios a través de un know-how que ha crecido en el transcurso de medio siglo, el gran número de productos probados para la construcción de hormigón armado así como nuestras unidades de negocio: separadores, tecnologías de encofrado, técnicas de armaduras, técnicas de estanqueidad y acústica de la construcción. Creamos componentes con nuevas funcionalidades y una mayor rentabilidad de los procesos de trabajo en obra.

Gracias a su marcado sentido del valor y a su integridad, MAX FRANK sabe cómo superar los obstáculos y ganarse a las diferentes partes para un objetivo común. Para ello, contribuye una capacidad de escuchar con atención y de plantear las preguntas adecuadas. Preguntas que ayudan a obtener nuevas perspectivas y a construir cada vez más una base en común.

En MAX FRANK lo llamamos:

BUILDING COMMON GROUND

www.maxfrank.com

DIVERSIDAD INDIVIDUAL

Los productos de MAX FRANK son técnicamente sofisticados, cuentan con amplio asesoramiento y detalladas explicaciones. Nuestro servicio es versátil y precisamente por eso muy personal.

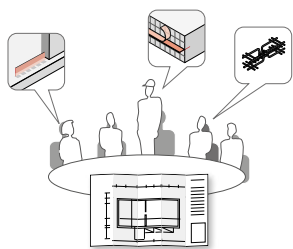

PLANIFICACIÓN

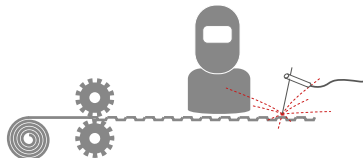

PRODUCCIÓN

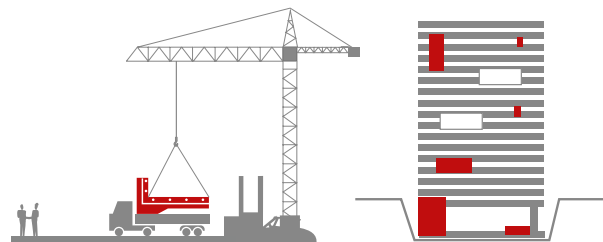

OBRA



NUESTRA FUERZA

Una gama de productos amplia, calidad comprobada, asesoramiento desde el inicio del proyecto, planificación, producción y suministro



BENEFICIOS PARA EL CLIENTE

Ahorro de costes y tiempo, un proveedor para todo



NUESTRA AMBICIÓN COMÚN

Estructuras de hormigón armado sostenibles y seguras

VISÍTE NUESTRO SITIO WEB: **www.maxfrank.com**

Puede navegar por la página web de una forma cómoda y sencilla para llegar rápido a los contenidos buscados. Además de información sobre nuestros productos, el sitio web también le ofrece una gran variedad de servicios. En ella encontrará interesantes funciones que le ayudarán en todas las fases de la construcción.



MAX FRANK BUILDINGS

Integramos esta herramienta en la página web para enlazar con una amplia información sobre los productos. El paisaje virtual le proporciona los productos óptimos para los diferentes tipos de aplicación: estación de ferrocarril, puente, edificio de oficinas, edificio de gran altura, edificio industrial, depuradora, museo, depósito de agua potable, túnel, central hidroeléctrica y edificio residencial.



BUSCADOR DE PRODUCTOS

Para encontrar el producto adecuado a su necesidad solo tiene que seleccionar el tipo de estructura o aplicación.

CONTENIDO



Separadores

página 6



Técnica de
encofrado

página 16



Tecnología de
armaduras

página 34



Técnica de
estanqueidad

página 48



Acústica de la
construcción

página 56

Separadores de hormigón fibrado

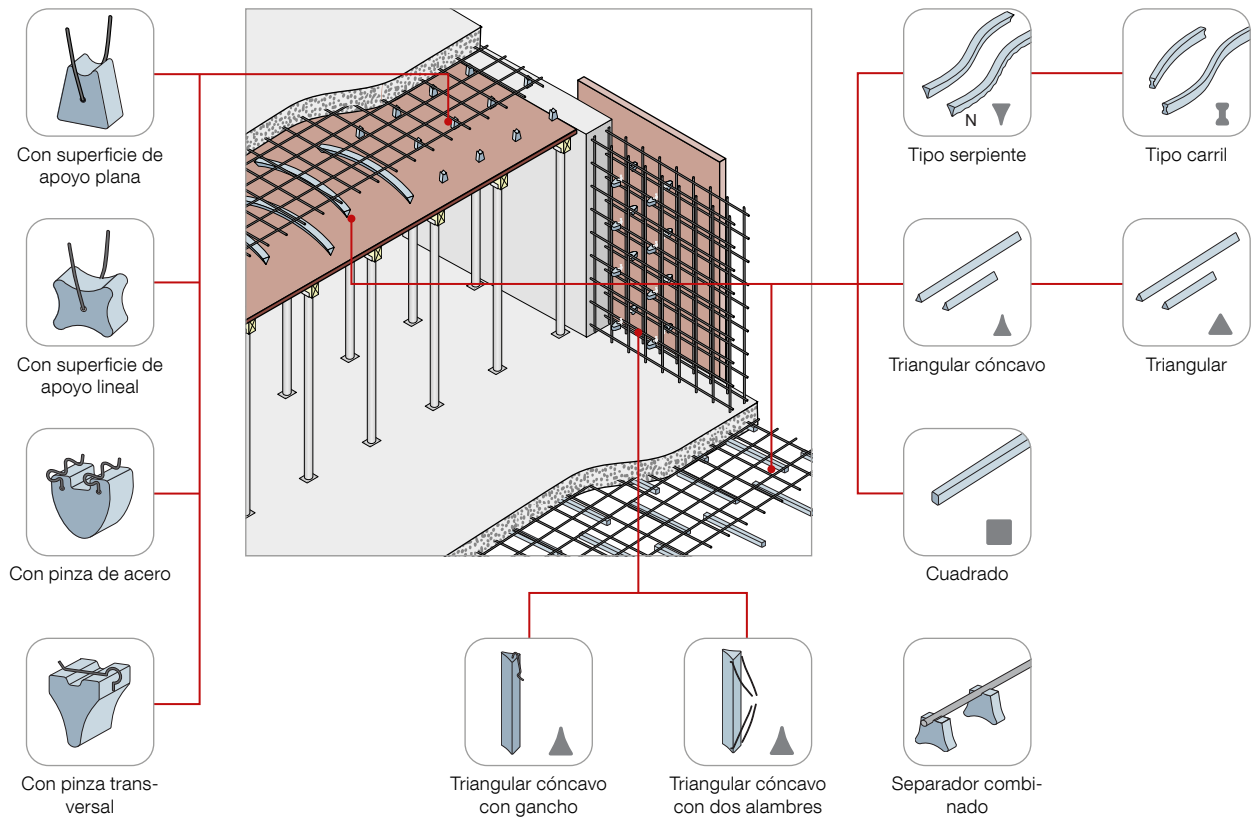

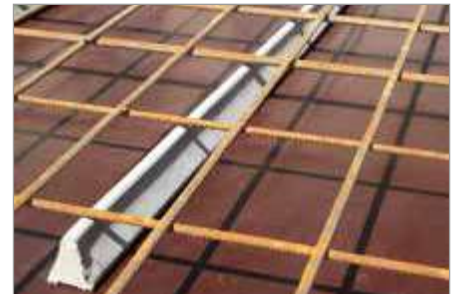
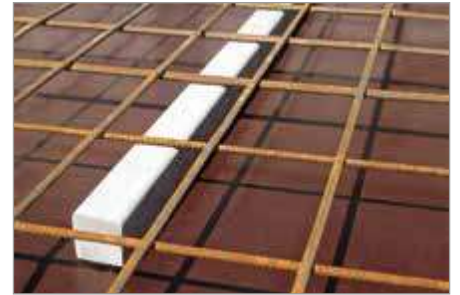
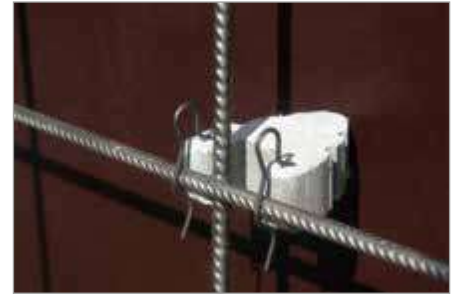
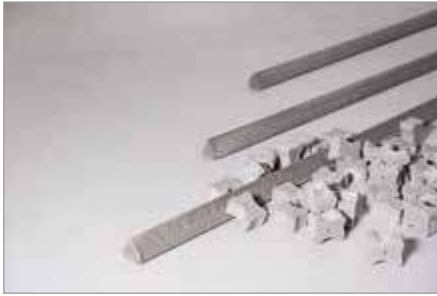

Separadores de hormigón colado



Con alambre

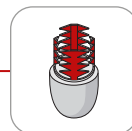
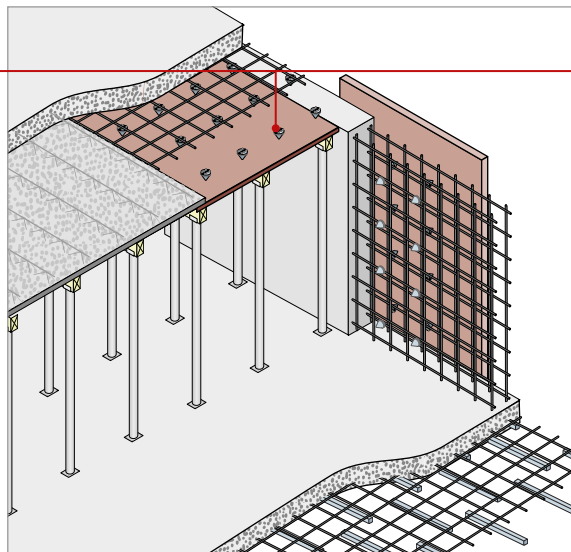

Con clip tipo volante

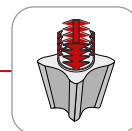

Con clip tipo volante

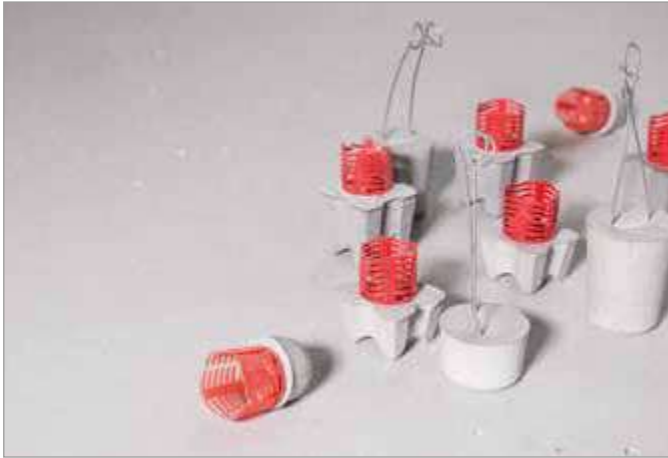

Separadores de plástico



Separadores lineales
U-Pro

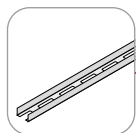

Separadores lineales
U-Pro "sin" para
aislamientos

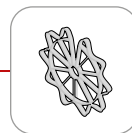
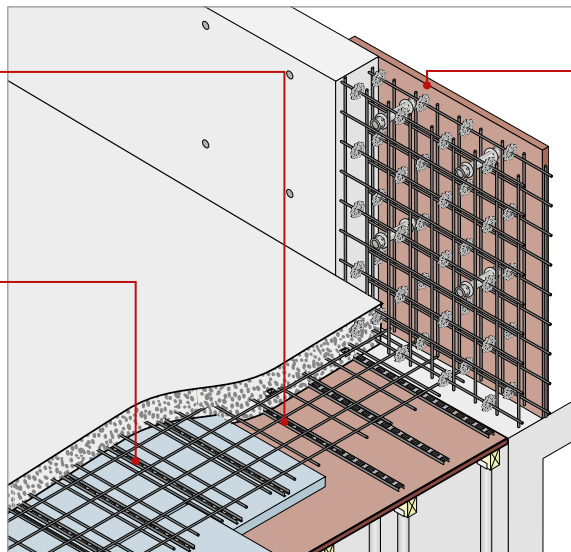

Separadores circulares
de plástico

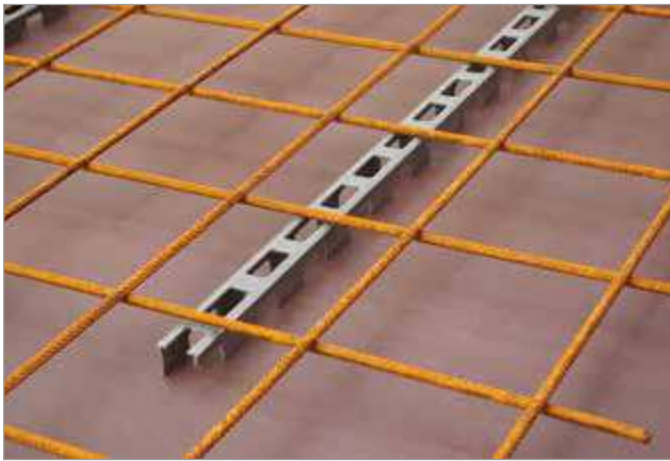
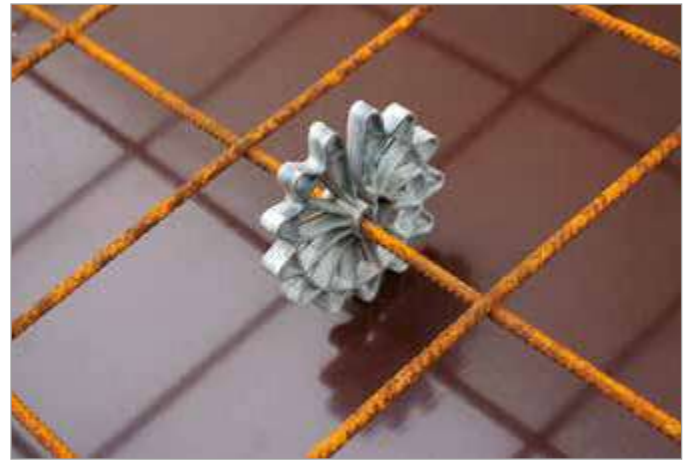

Separador metálico de doble capa de armadura

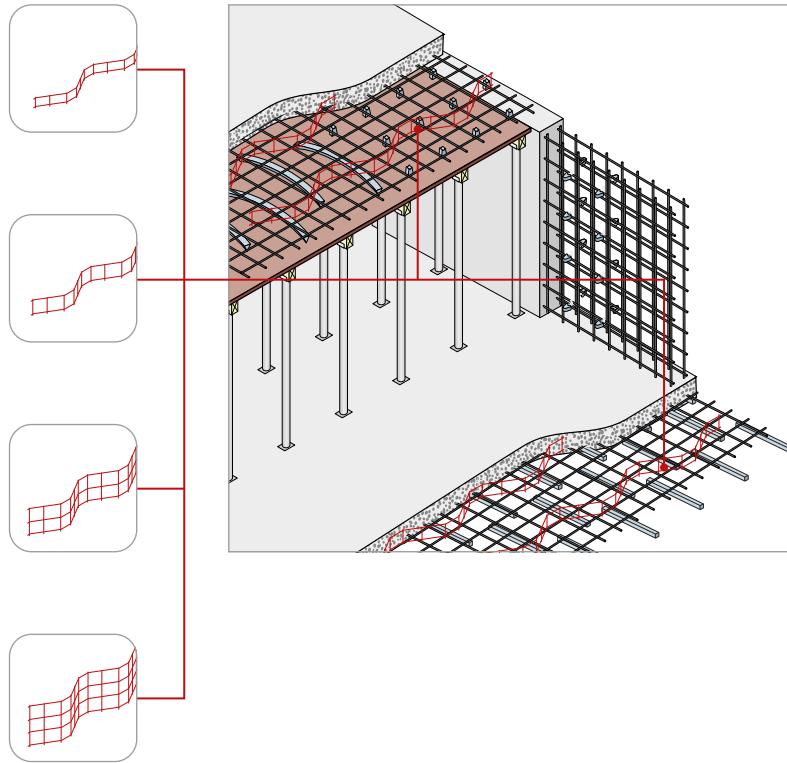

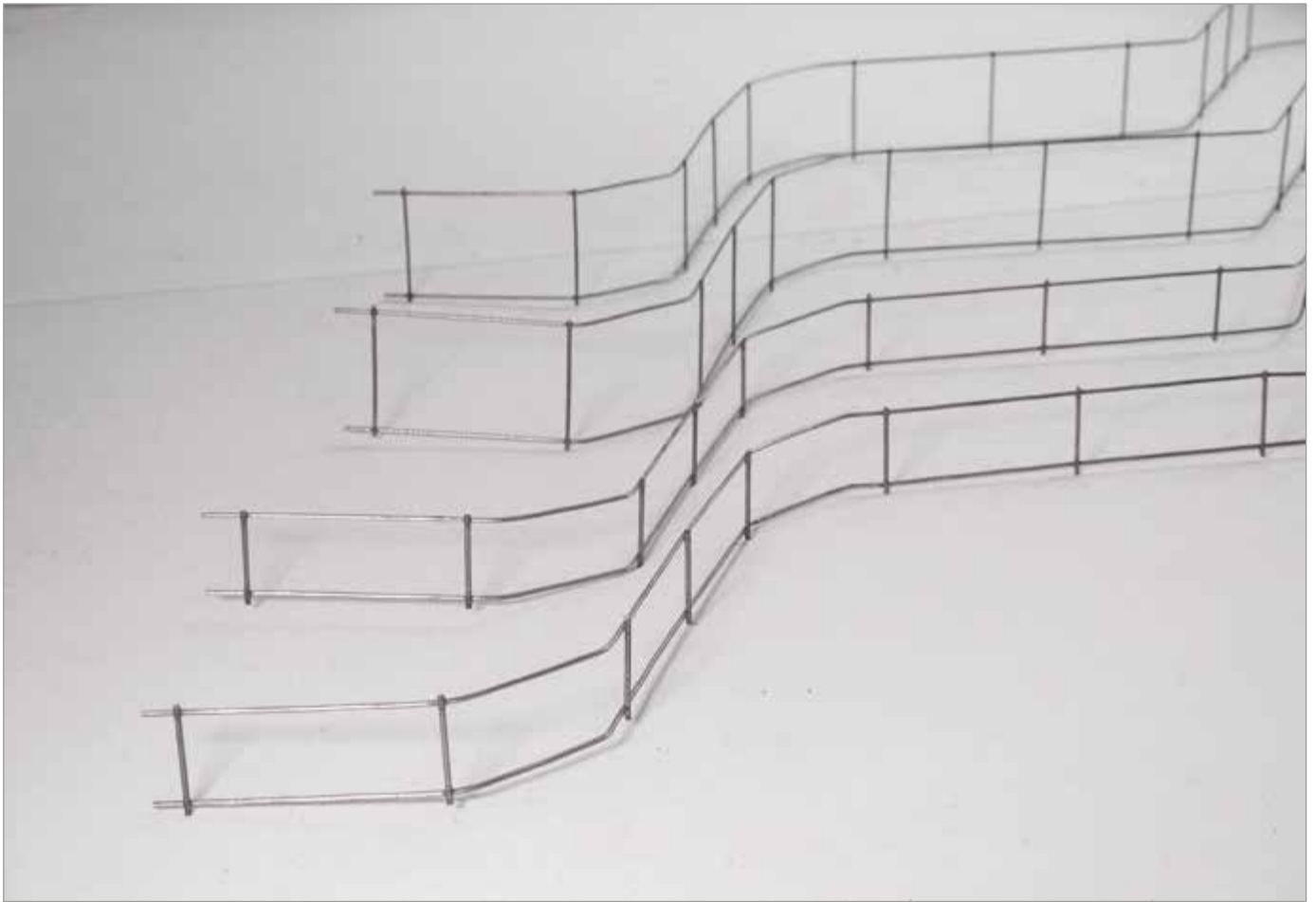

Tubos distanciadores de hormigón fibrado

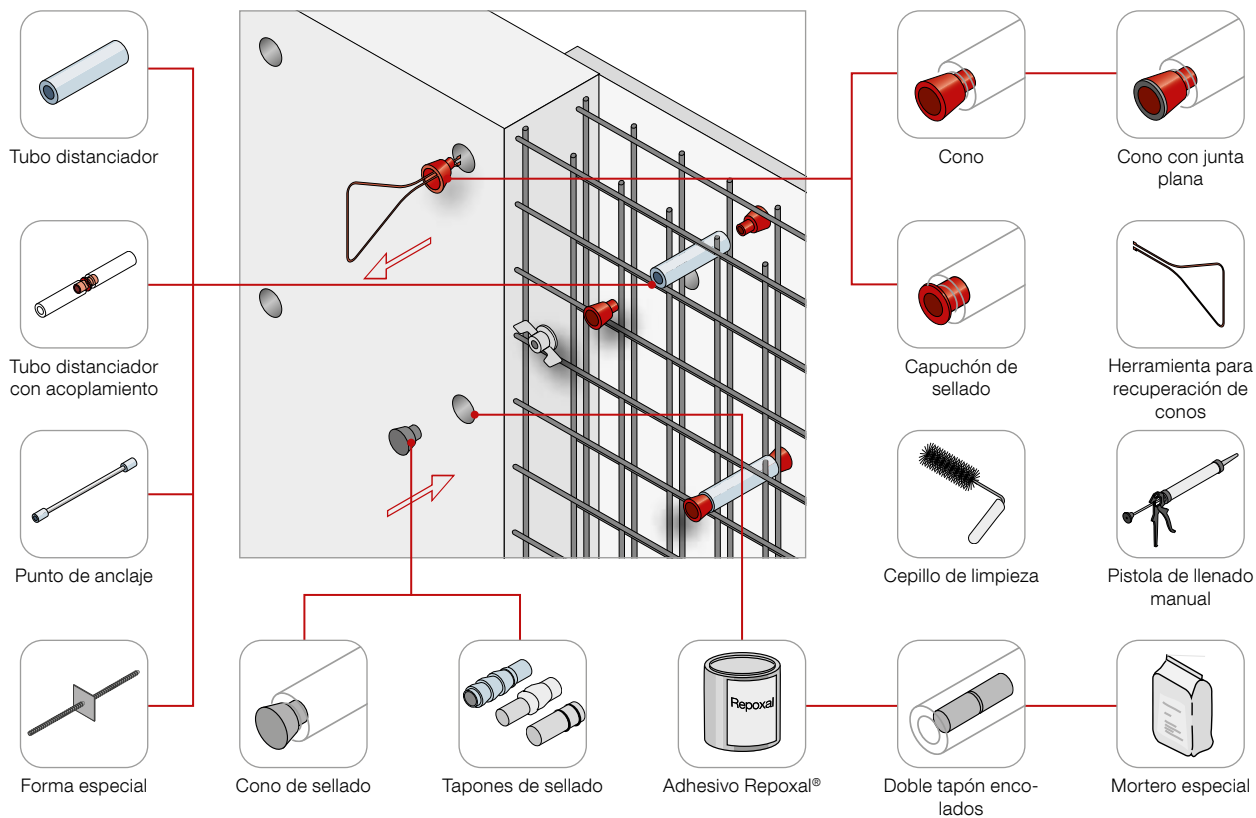

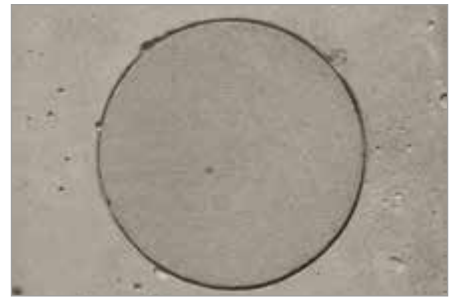
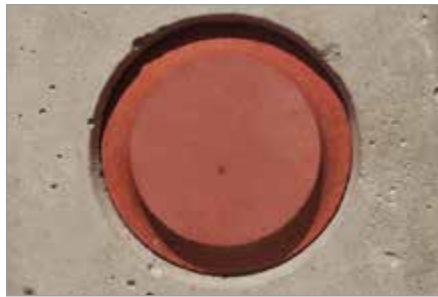

Encofrado perdido Pecafil®

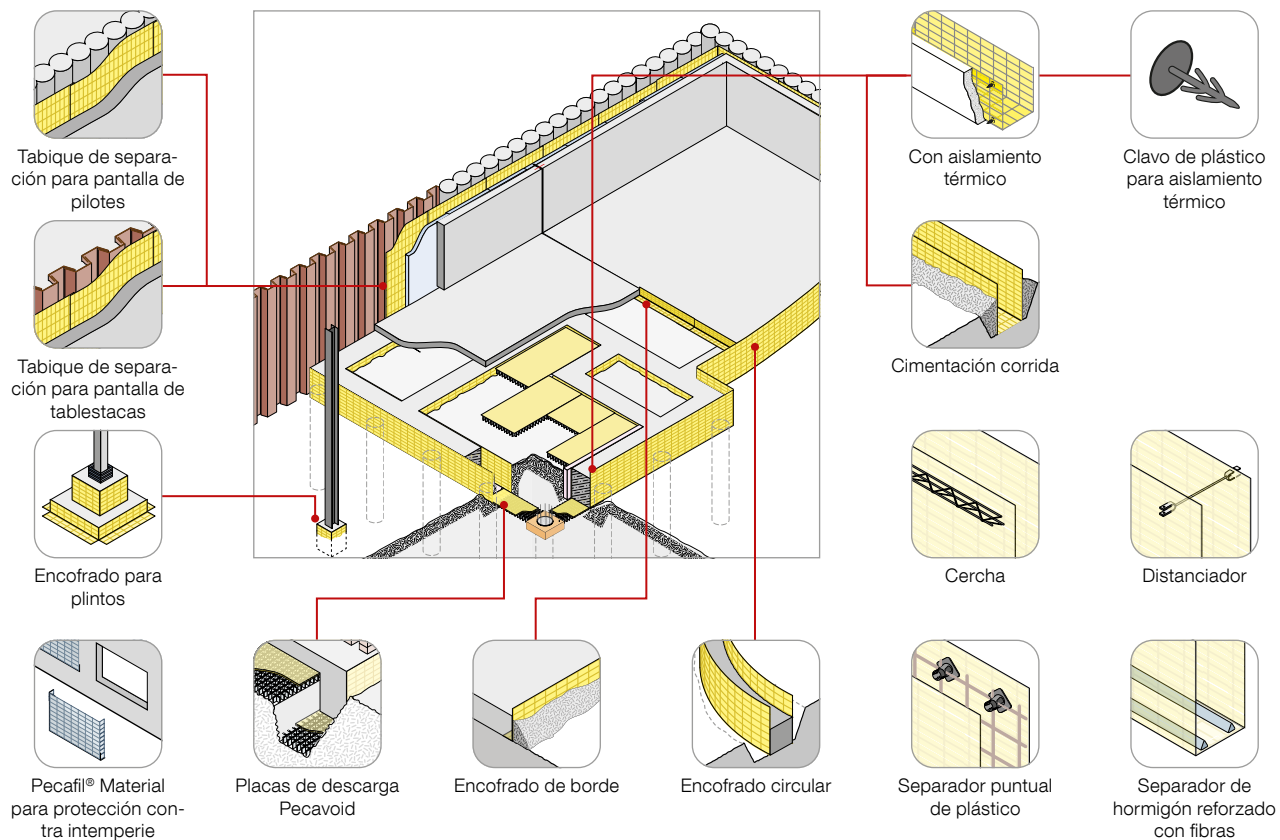

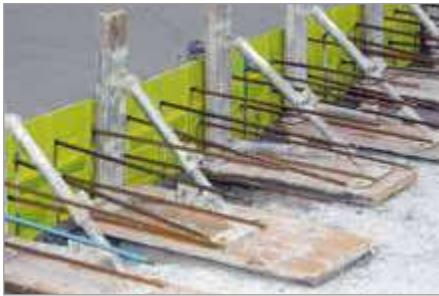
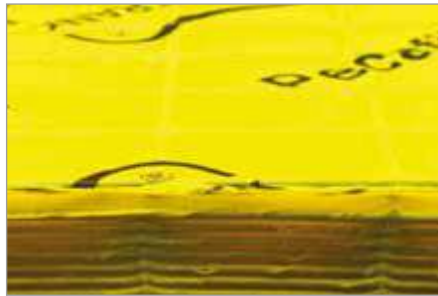

Pecavoid® solución para terreno expansivo

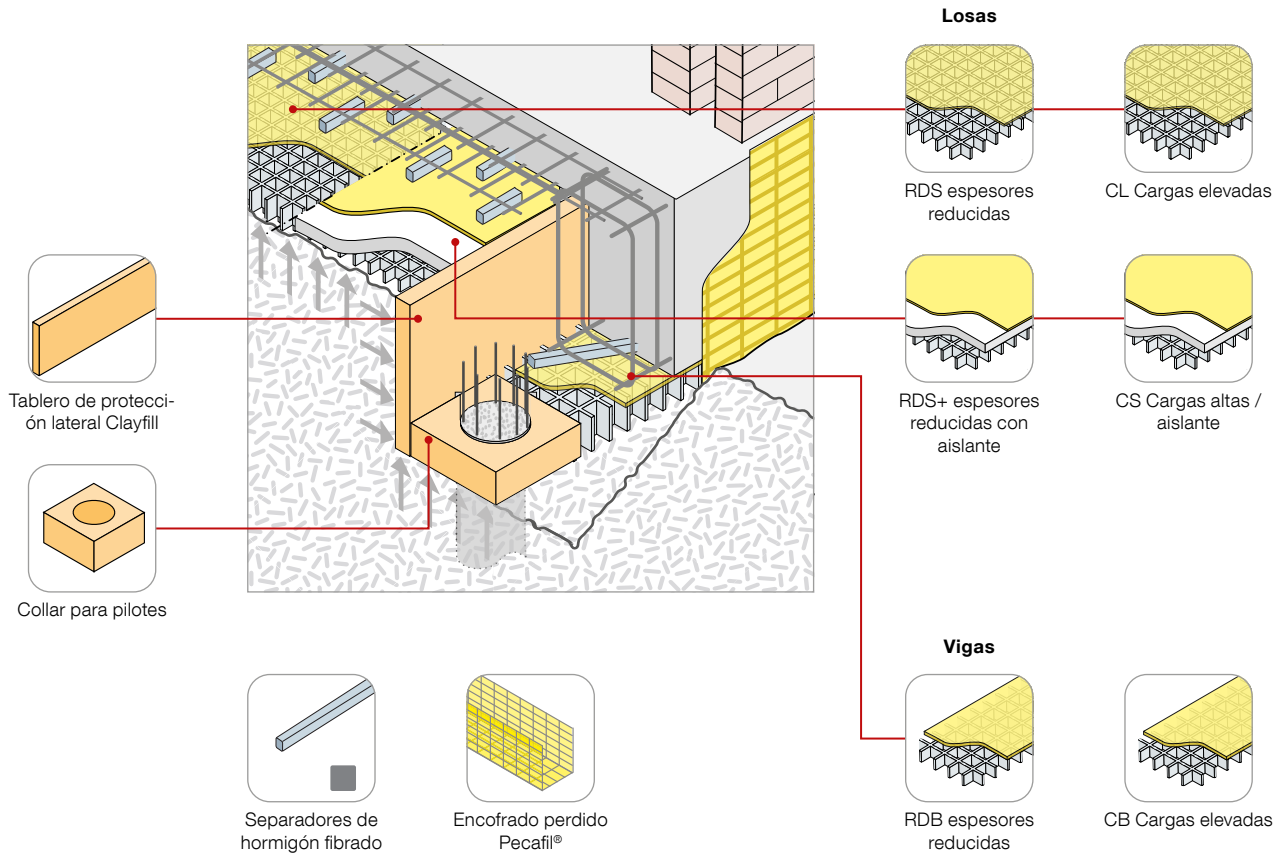



Encofrado Stremaform® para juntas de construcción

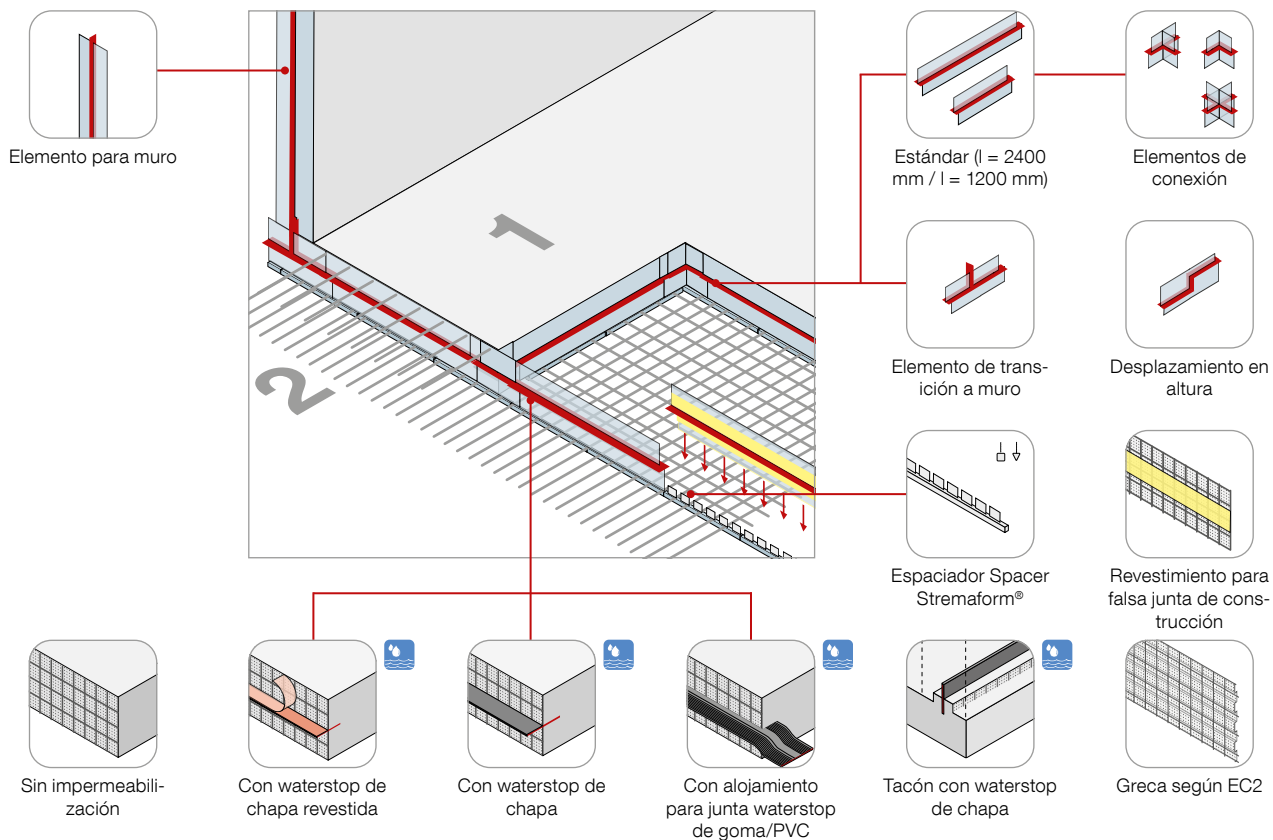



Encofrado Stremaform® para juntas de dilatación

Junta de aislamiento acústico

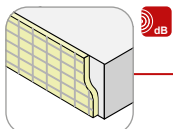

Junta de aislamiento acústico

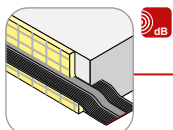

Con waterstop elastomérico

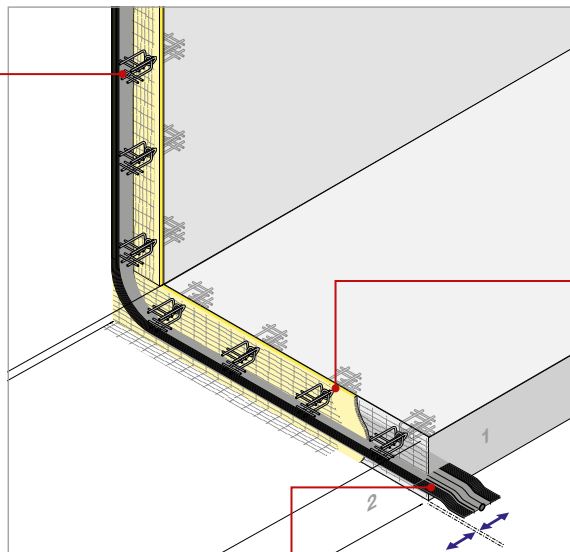

Junta de dilatación

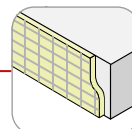

Sin impermeabilización

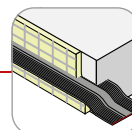

Con waterstop elastomérico

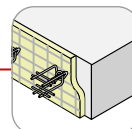

Con transmisión de esfuerzos cortantes

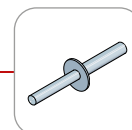

Pasador a cortante Egcodubel

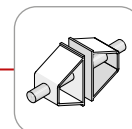

Pasador a cortante para cargas dinámicas

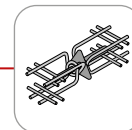

Pasador a cortante Egcodorn®

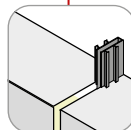

Waterstop elastomérico de cierre

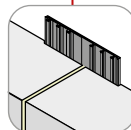

Waterstop elastomérico exterior

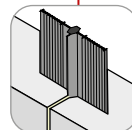

Waterstop elastomérico interior

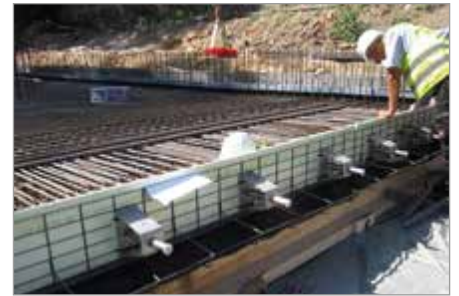
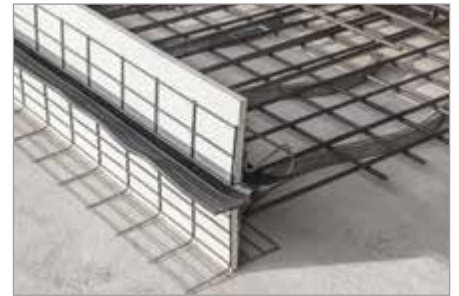

Encofrado de columnas Tubbox®

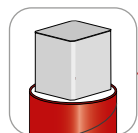

Pilar cuadrado

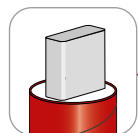

Pilar rectangular

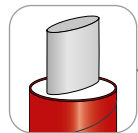

Forma especial



Pilares en "V"

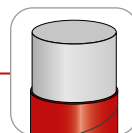
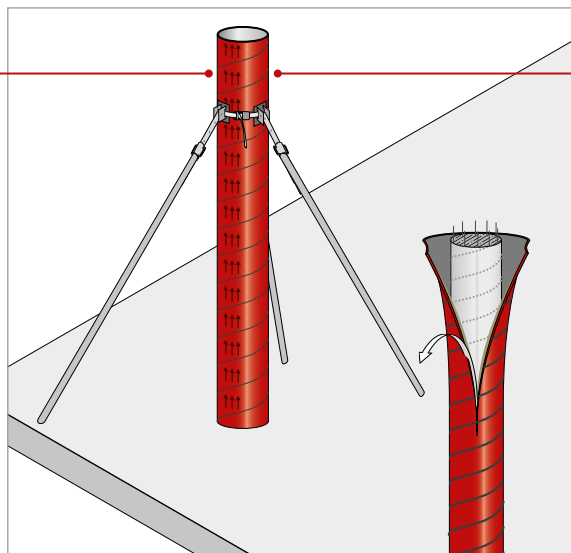

Pilar circular



Superficie sin poros



Superficie en espiral



Superficie lisa

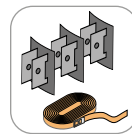

Componentes



Lámina Zemdrain® CPF



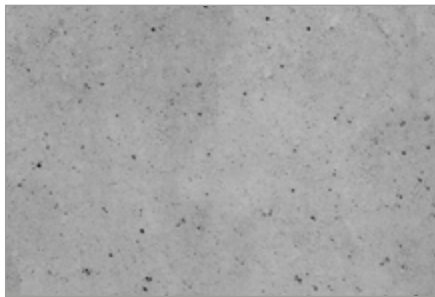
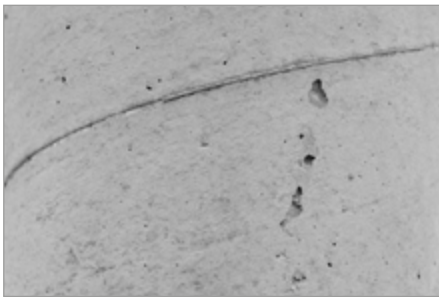
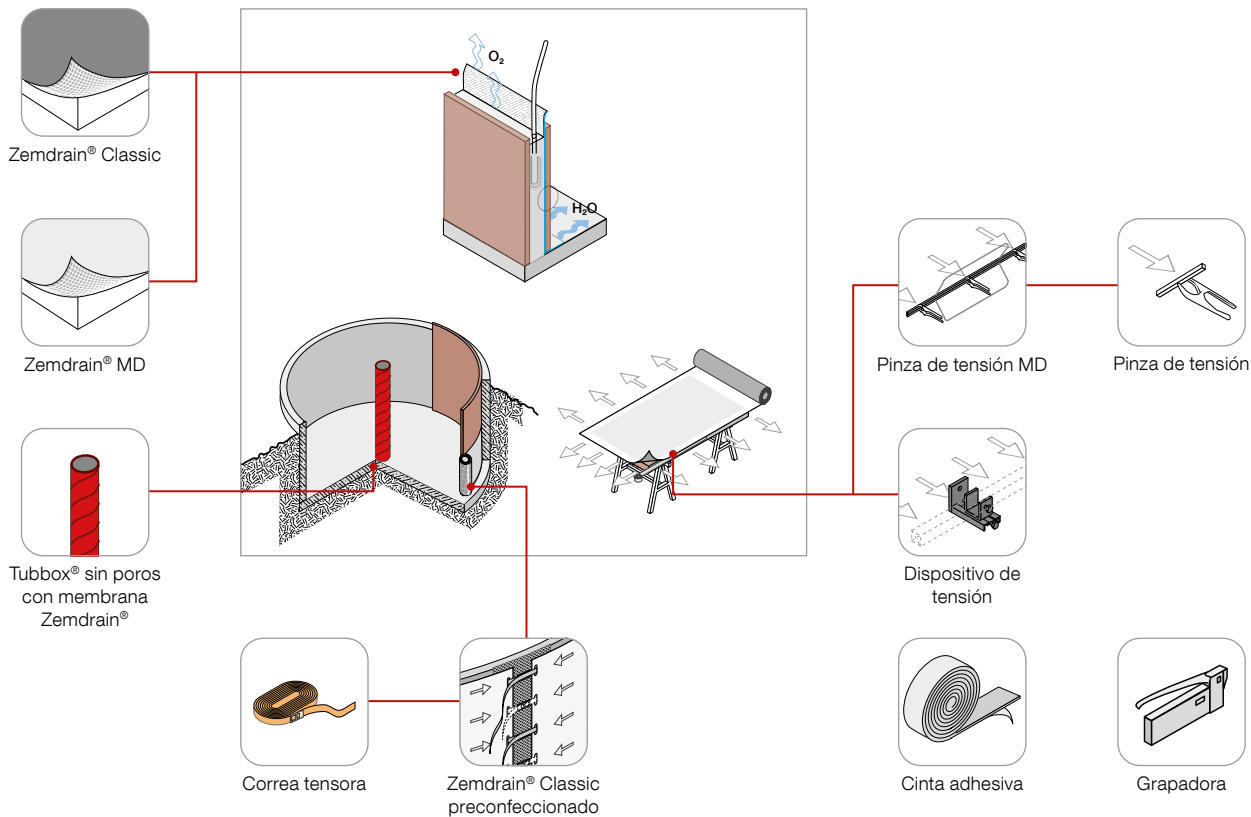

Encofrado de borde para balcón, losa y doble muro

Parapeto estándar (AKF)

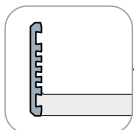

Elemento estándar de parapeto

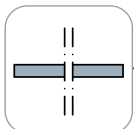

Bordes de 90° en ambos lados

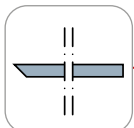

Borde unilateral de 45°

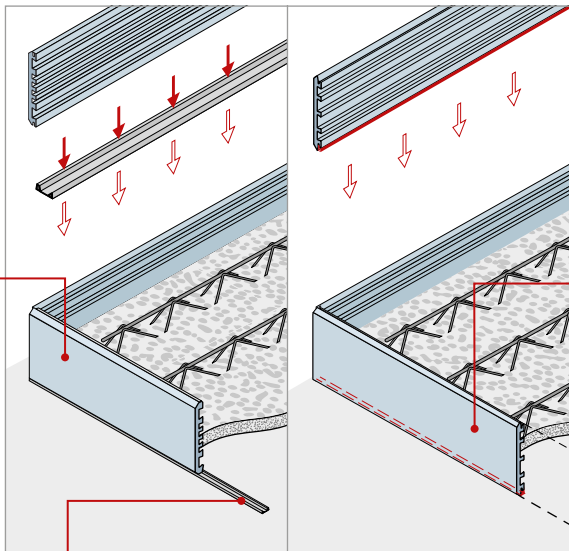

Perfil antigoteo de plástico

Parapeto premontado con listones impermeabilizantes (AKZ)

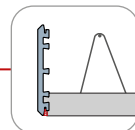

Parapeto con labio anti-goteo

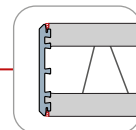

Parapeto doble muro con doble labio anti-goteo

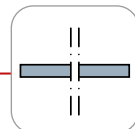

Bordes de 90° en ambos lados

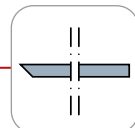

Borde unilateral de 45°



Encofrado para hueco y cálices

Caja de encofrado

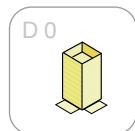

100 x 100 mm

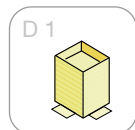

150 x 150 mm

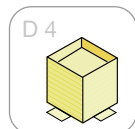

200 x 200 mm

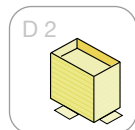

150 x 240 mm

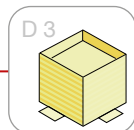

240 x 240 mm

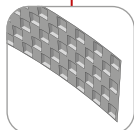

Perfil conformado para juntas

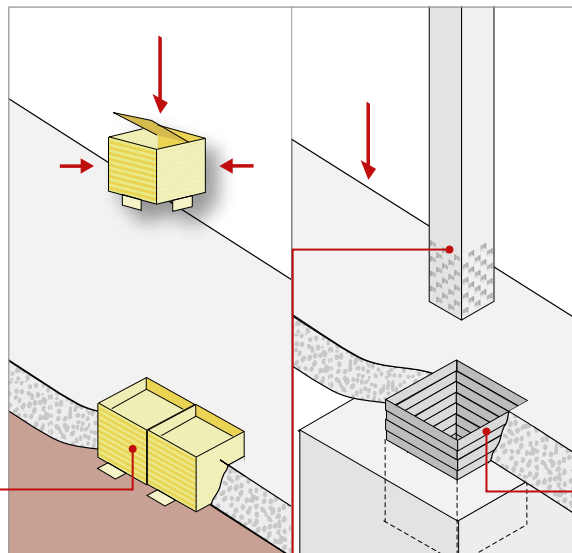

Encofrado de cálices

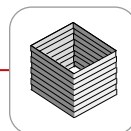

Cálices cerrados de fábrica

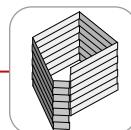

Cálices abiertos

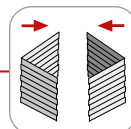

Cálices en ángulo



Agente desencofrante Trennfit

Componentes

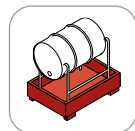

Bandeja de goteo con soporte para bidón



Pulverizador



Accesorios para pulverizador

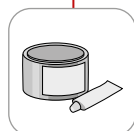
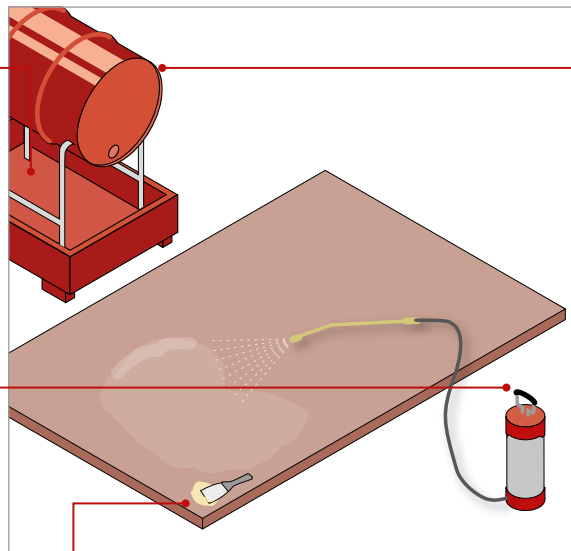

Masilla especial

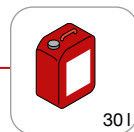

30 l

Trennfit Pure

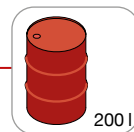

200 l

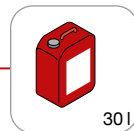

30 l

Trennfit Super

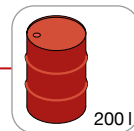

200 l

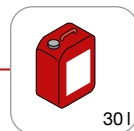

30 l

Trennfit

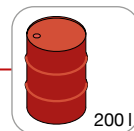

200 l





Egcoflex® disyuntor térmico para balcones y voladizos

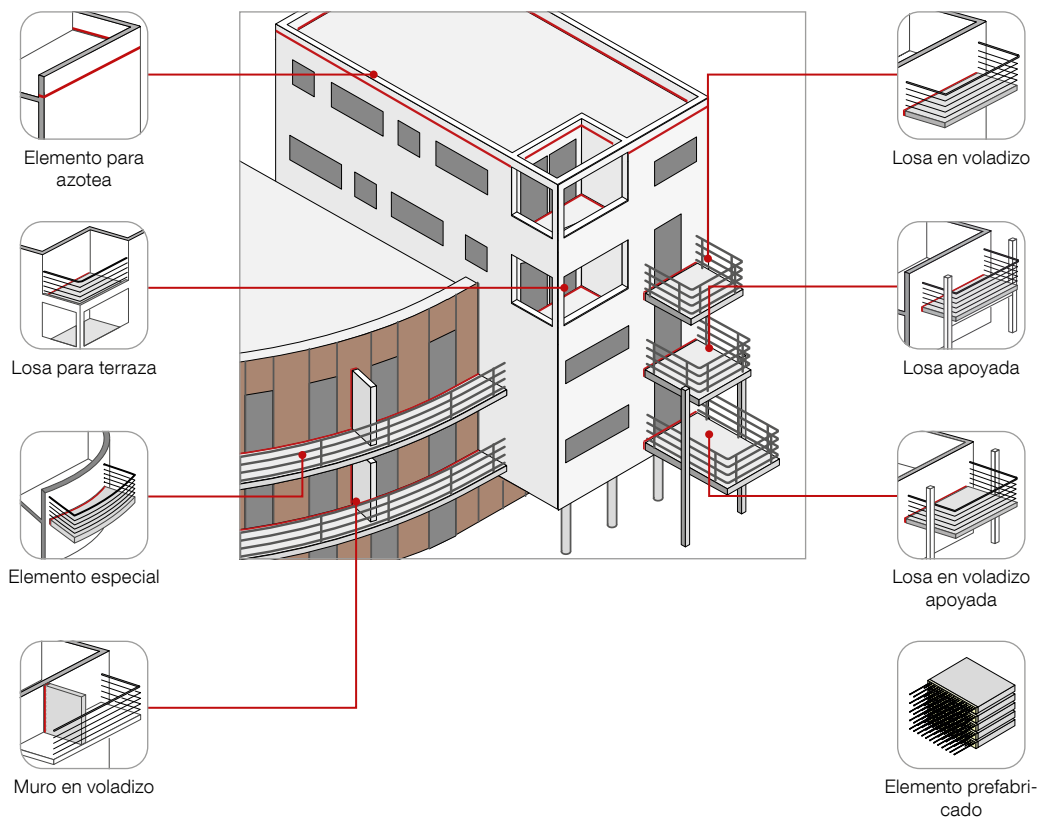

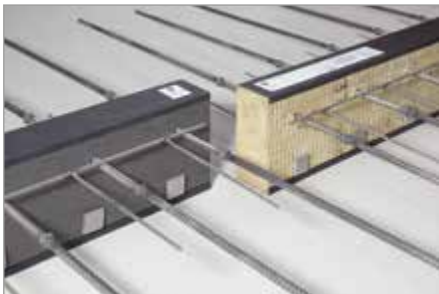

Egobox® FST disyuntor térmico para estructuras metálicas

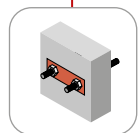
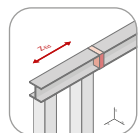

Para esfuerzos de tracción

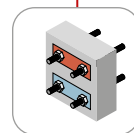
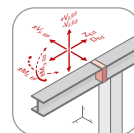
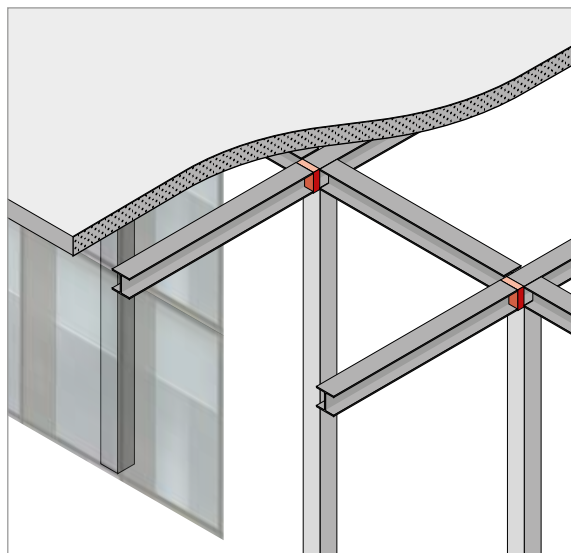

Para esfuerzos de momento, normales y de cortante

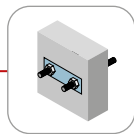
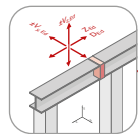

Para esfuerzos normales y de cortante

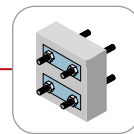
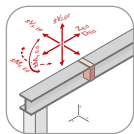

Para esfuerzos alternantes de momento, normales y de cortante



Pasador a cortante Egcodorn®

Pasadores



Egcodorn®
SWN / SWQ

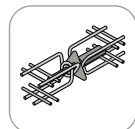

Egcodorn® WQ

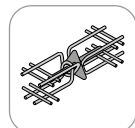

Egcodorn® WN

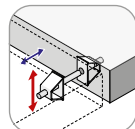

Egcodorn® DND

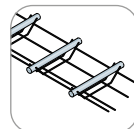
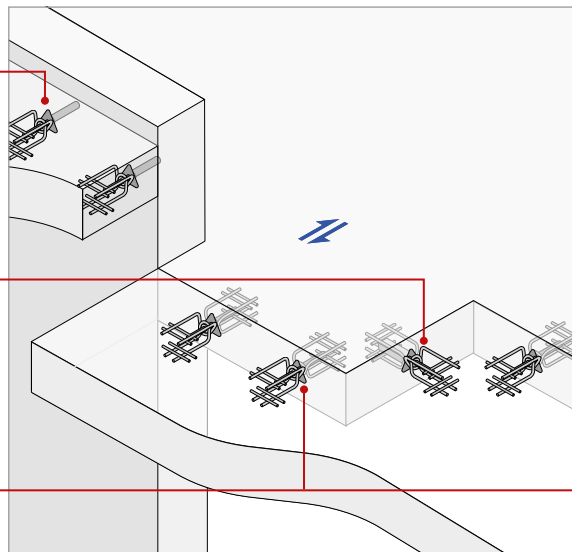

Soporte para Egco-
dubel

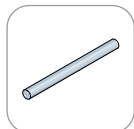

Egcodubel con re-
vestimiento de acero
inoxidable

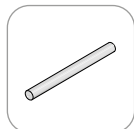

Egcodubel galva-
nizado

Pasador con vaina

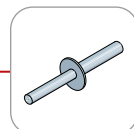

Egcodubel para
movimientos longitu-
dinales



Egcodubel para de
movimientos longitudi-
nales, vaina de plástico

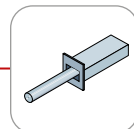

Egcodubel para mo-
vimientos longitudi-
nales y transversales



Protección contra
incendios

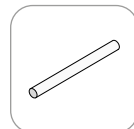

Egcodubel con recu-
brimiento completo

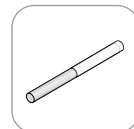

Egcodubel con recu-
brimiento a la mitad

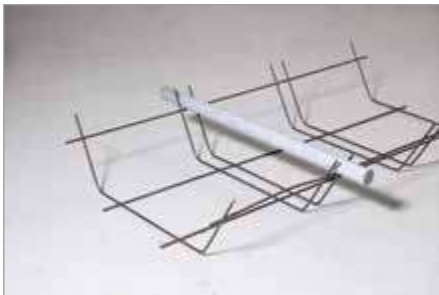
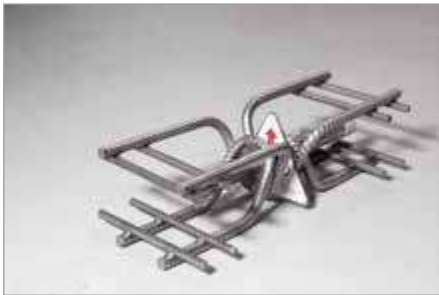

Caja de esperas Stabox®

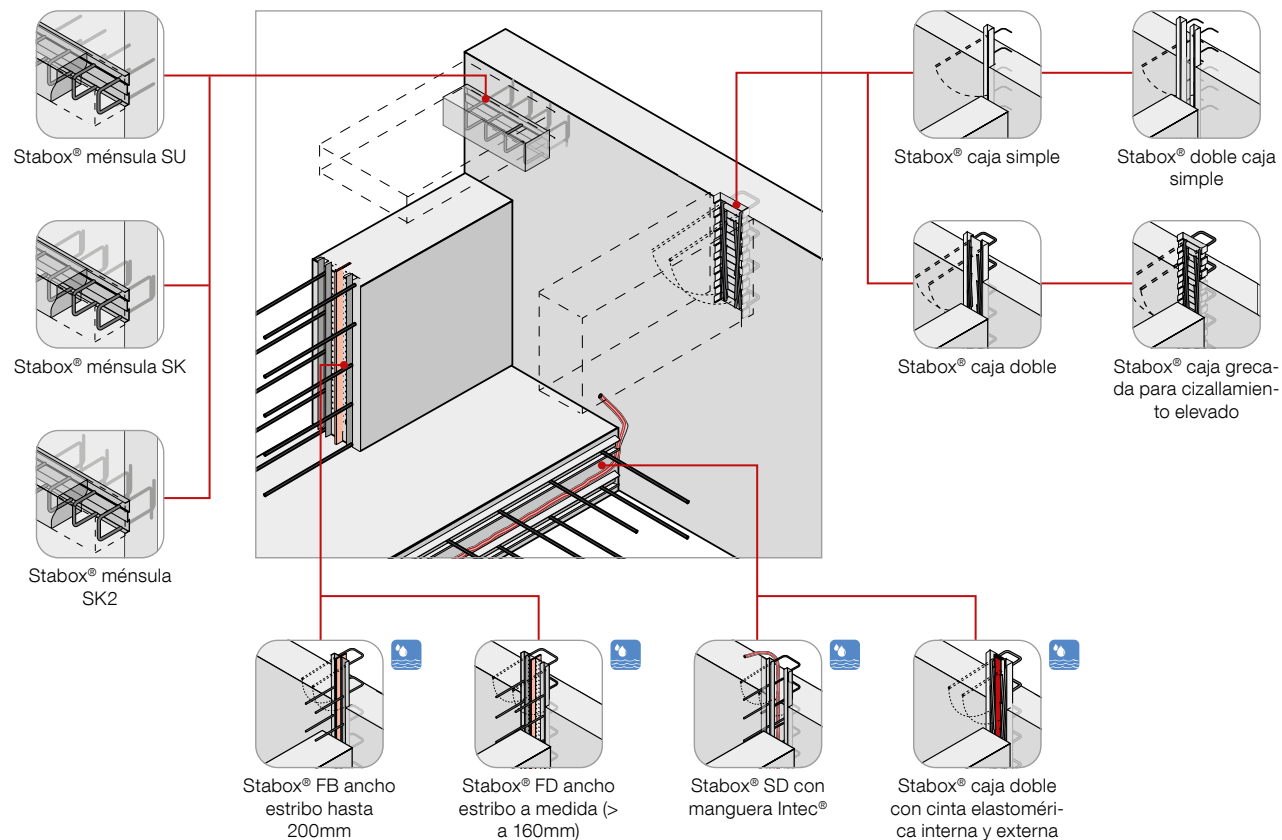

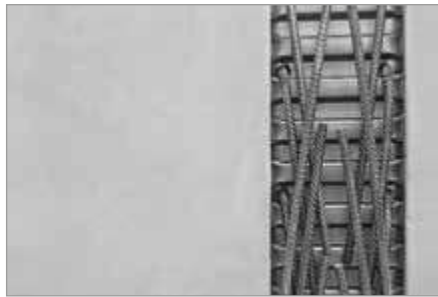

Coupler MAX FRANK conexión roscada

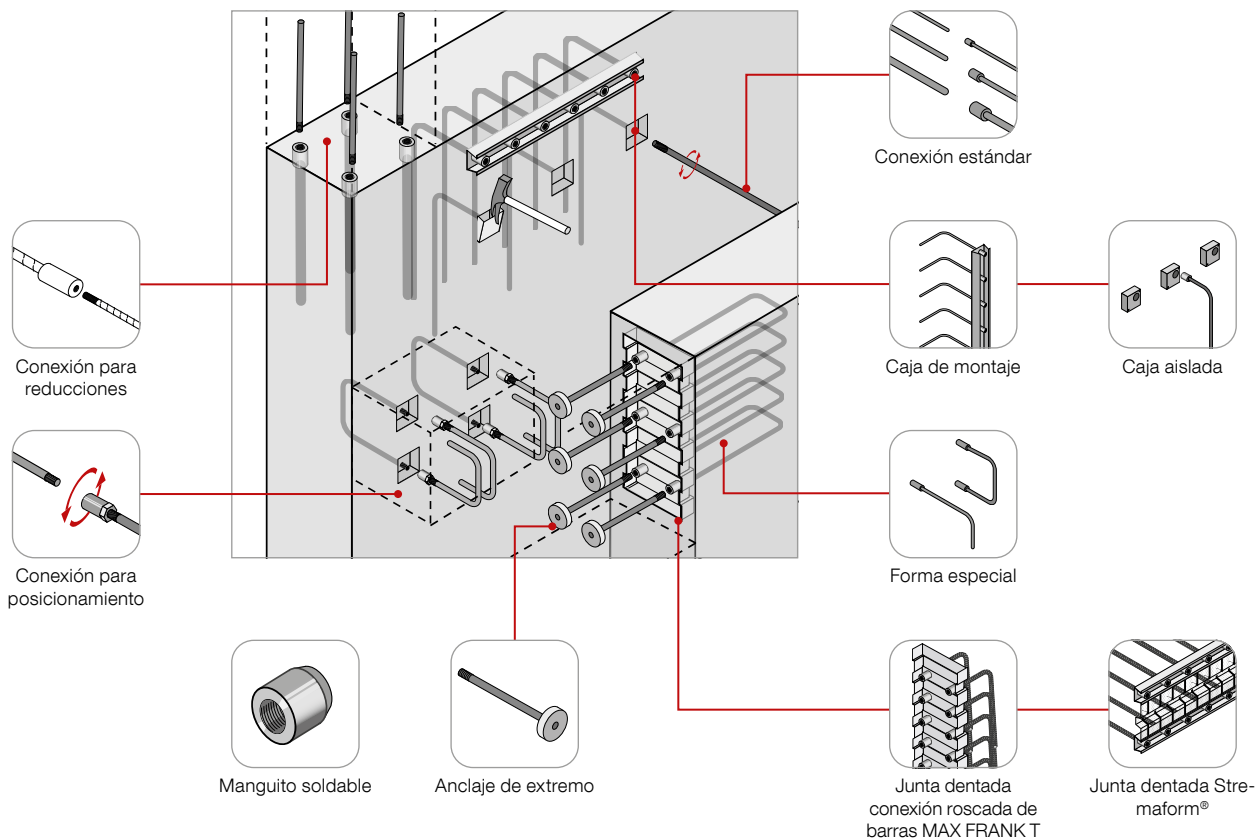



Armadura de punzonamiento Shearail®

Diseño



Patrón de disposición radial



Patrón de distribución ortogonal

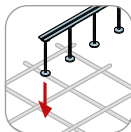

Fijación desde arriba hacia abajo

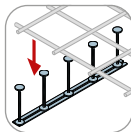

Fijación desde abajo

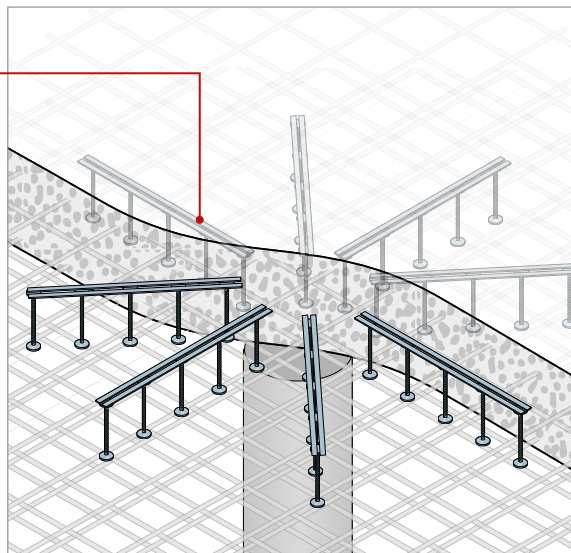

Alturas de pernos variables

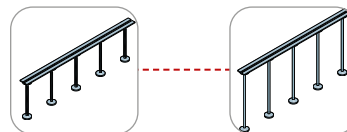

Número de pernos por carril variable

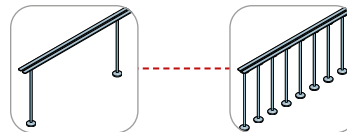

Diámetro de los pernos

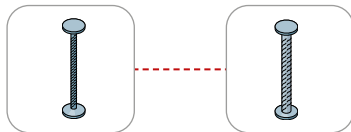

Ø 10, 12, 14, 16, 20, 25 mm

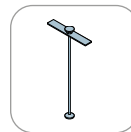

Pletina de armadura

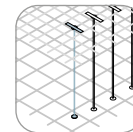

perno de doble cabeza



Refuerzo de mampostería Brick-Track®

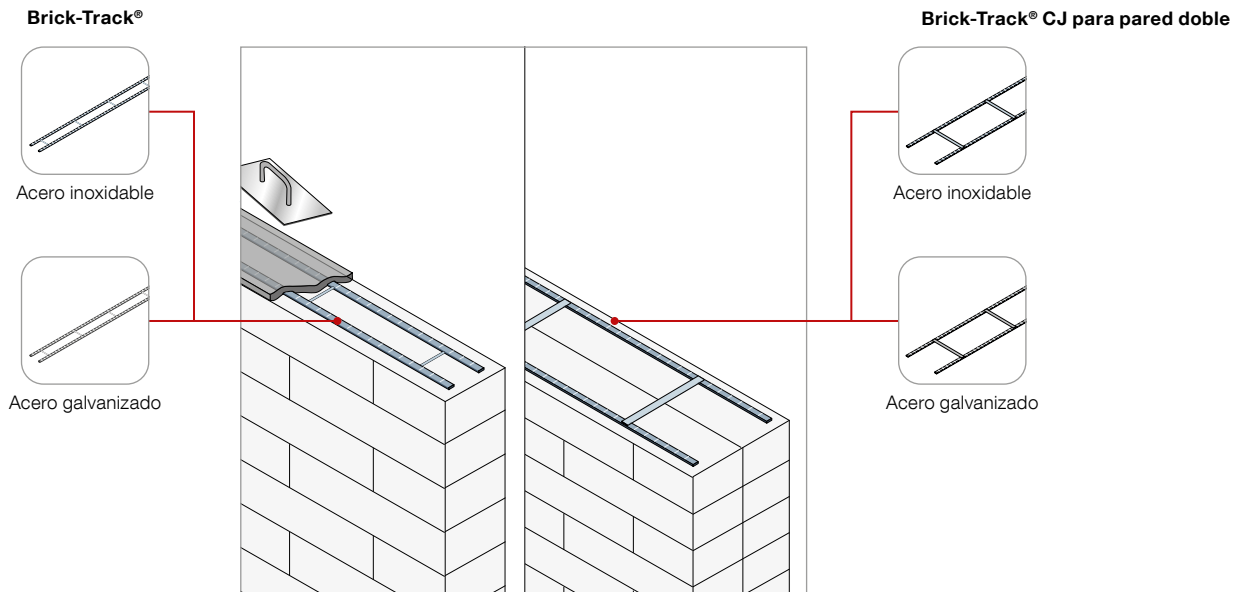

Piezas especiales disponibles

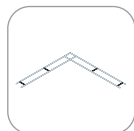

Esquina

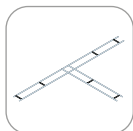

T



Curvado



Sistema de impermeabilización de subestructuras Zemseal®

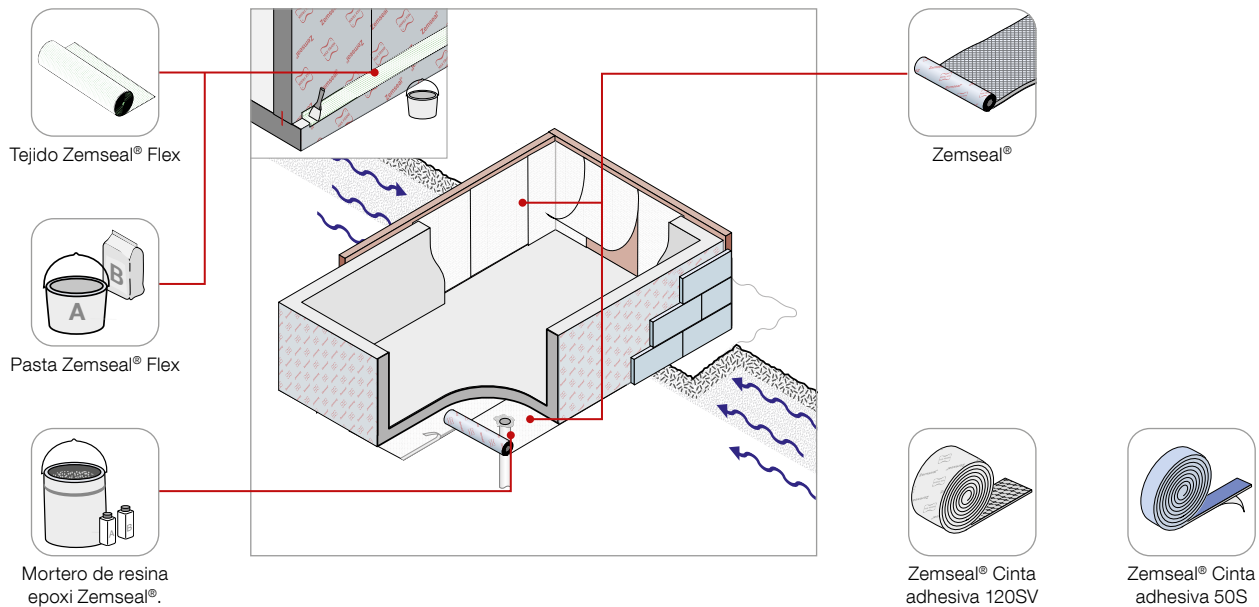

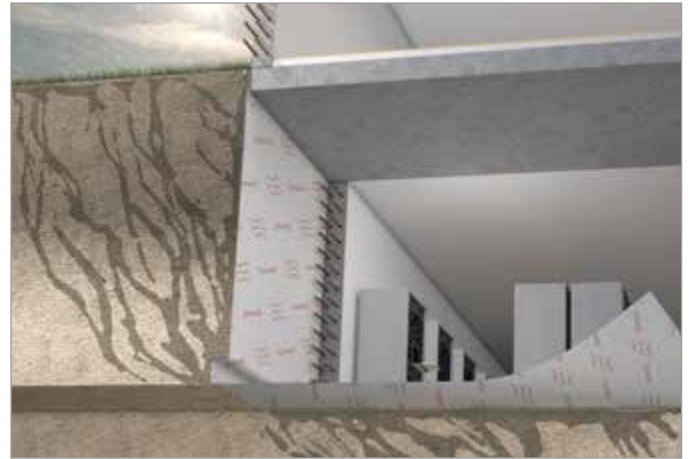

Junta de estanqueidad Fradiflex®

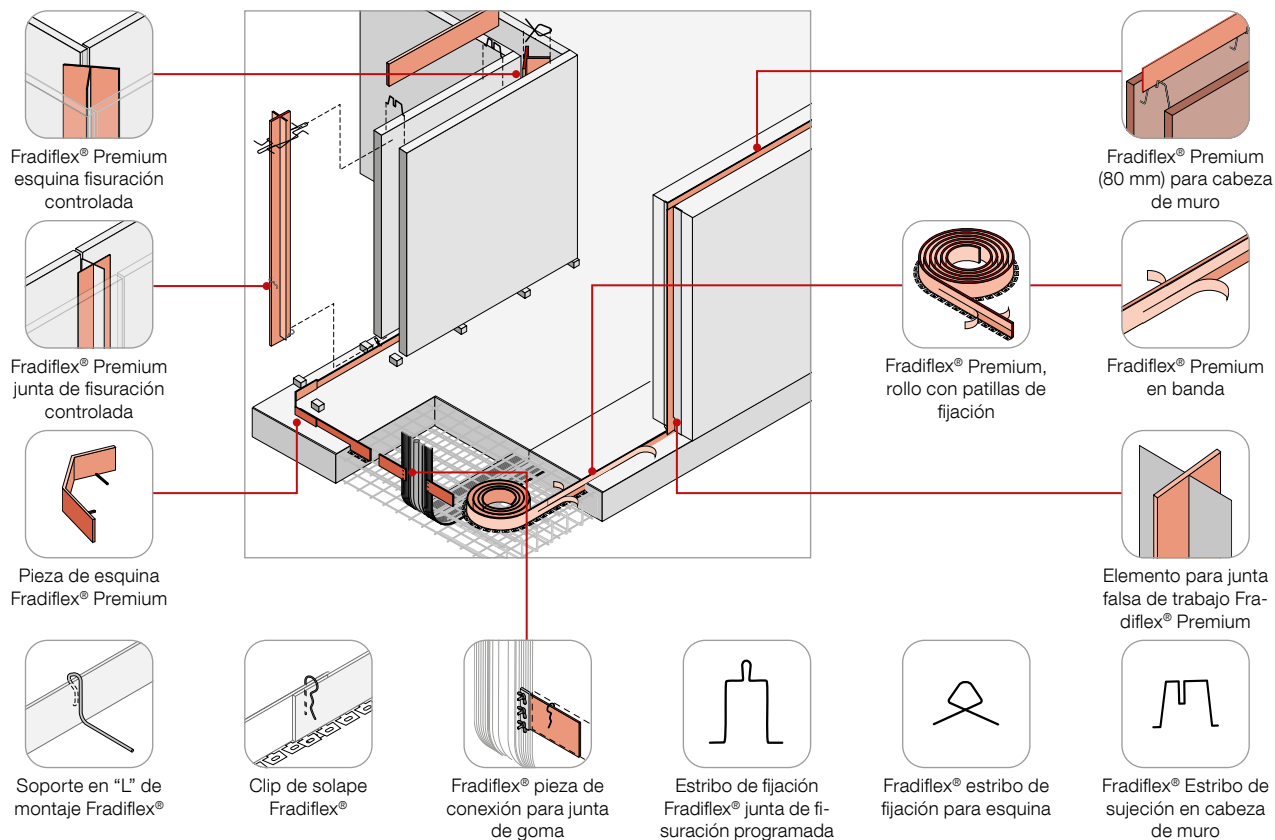

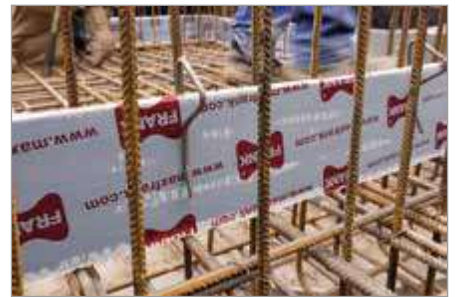

Sistema de mangueras de inyección Intec®

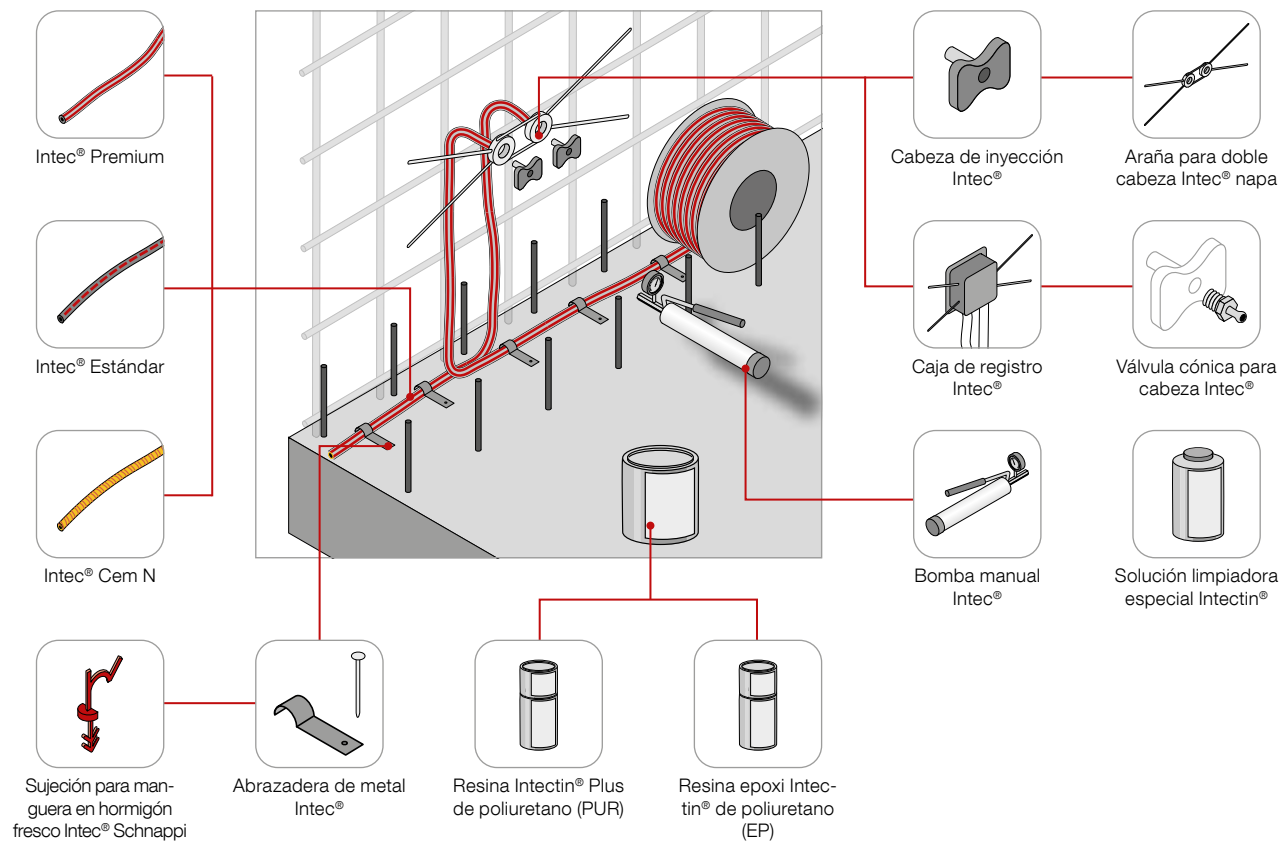

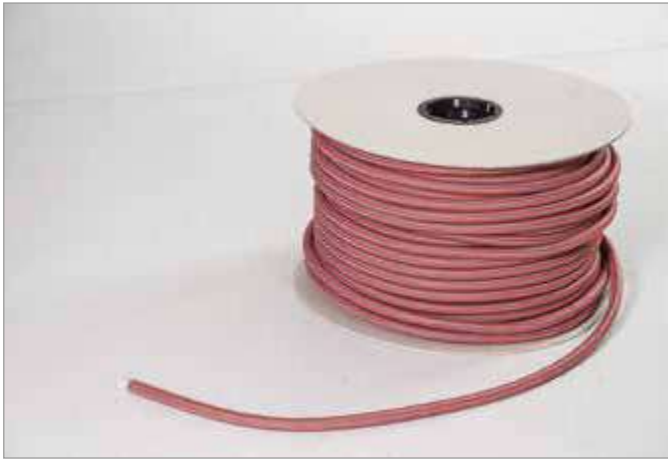

Cordón expansivo Cresco®

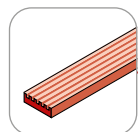

Cresco® GR

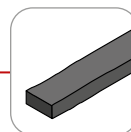
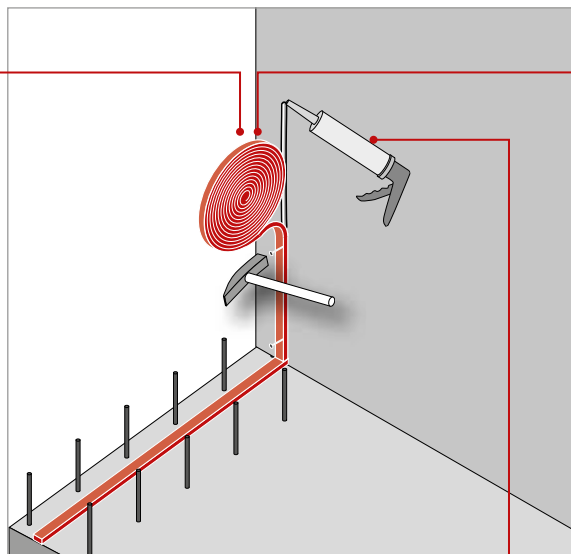

Cresco® BT

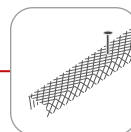

Rejilla de fijación y protección Cresco®

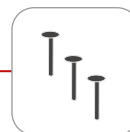

Clavo de fijación Cresco®



Adhesivo de fijación Cresco®



Absorbente acústico ambiental Sorp 10®

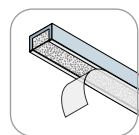

Sorp 10®

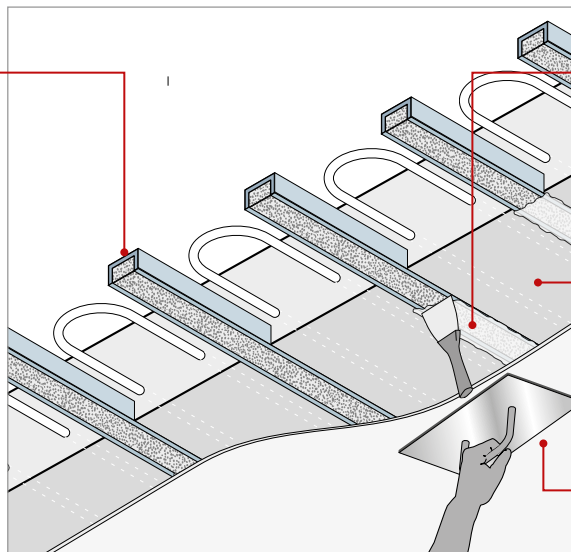

Revestimiento acústicamente permeable

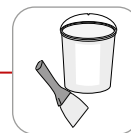

Masilla de relleno
Sorp

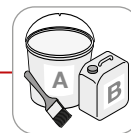

Imprimación Sorp

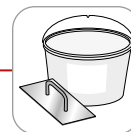

Masilla acústica
Sorp

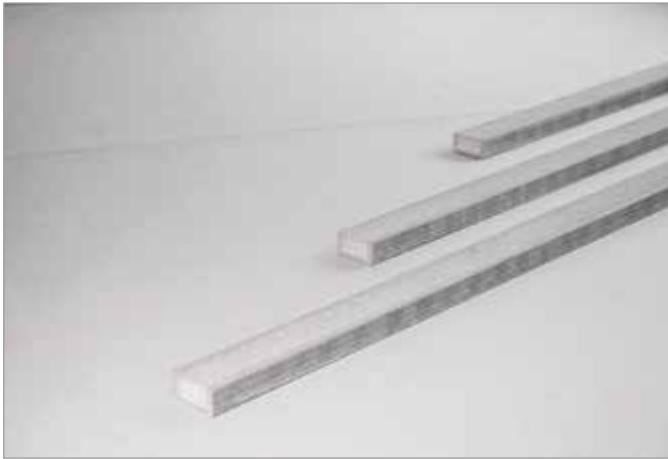

Pasador a cortante con aislamiento acústico Egcopal

Prefabricado

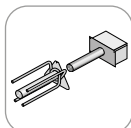

Egcopal SPX F

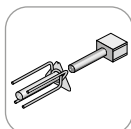

Egcopal SPH F

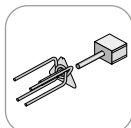

Egcopal SP F

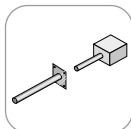

Egcopal SP light F

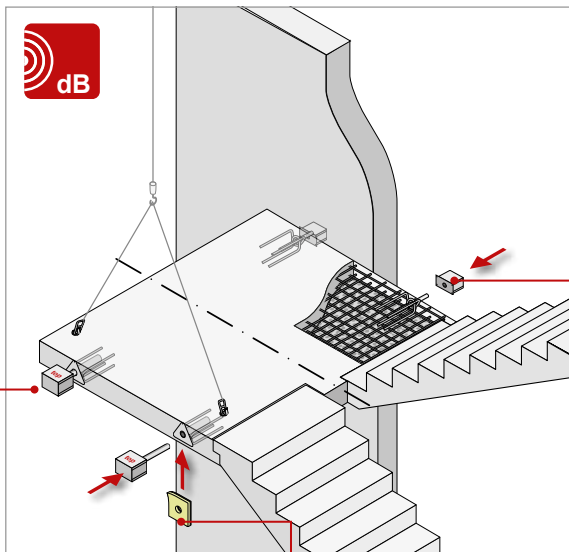

Hormigón in situ

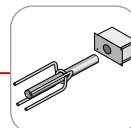

Egcopal SPX O

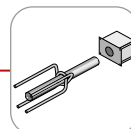

Egcopal SPH O

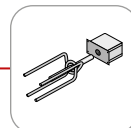

Egcopal SP O

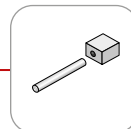

Egcopal SP light O

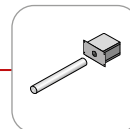

Egcopal SP light OB

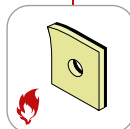

Manguito de protección contra incendios



Desacoplador de descansillo Egcosono

Prefabricado



Egcosono SP F



Egcosono SPV F



Egcosono SPH F

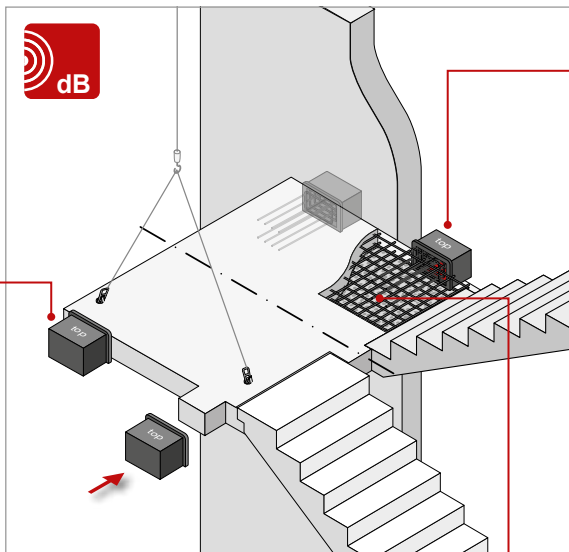

Hormigón in situ

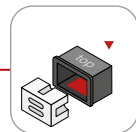

Egcosono SP O

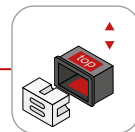

Egcosono SPV O

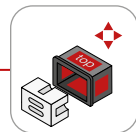

Egcosono SPH O

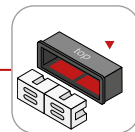

Egcosono SPL O

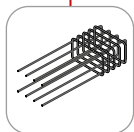

Armadura Egcosono



Desacoplador de escalera Egcostep®

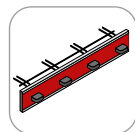

Egcostep® SP S4

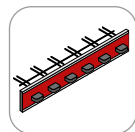

Egcostep® SP S6

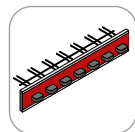

Egcostep® SP S7

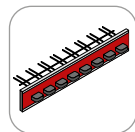

Egcostep® SP S8

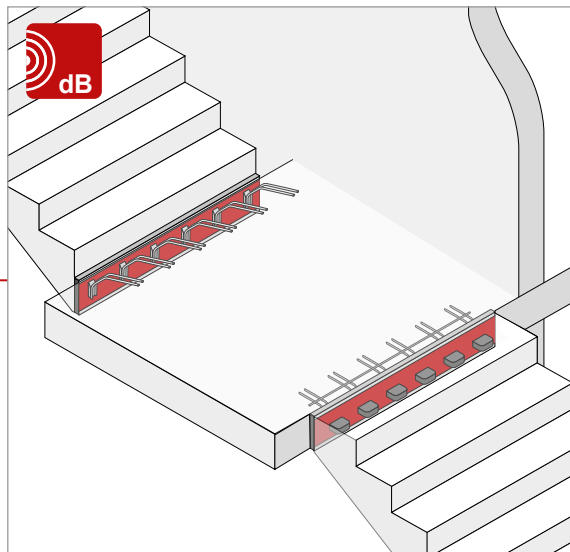



Apoyo de escalera Egcoscal

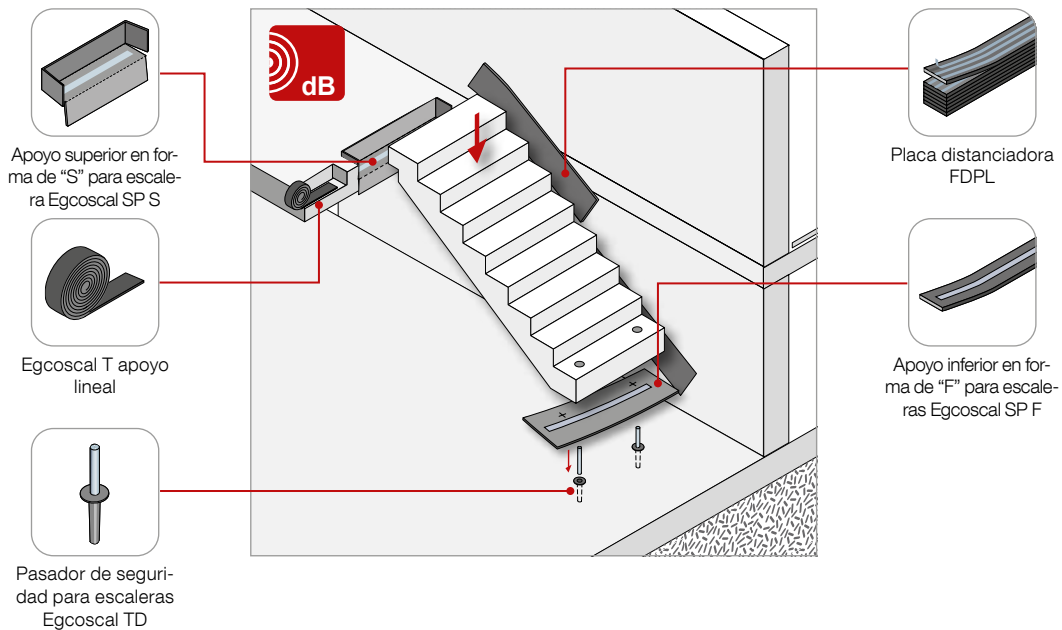

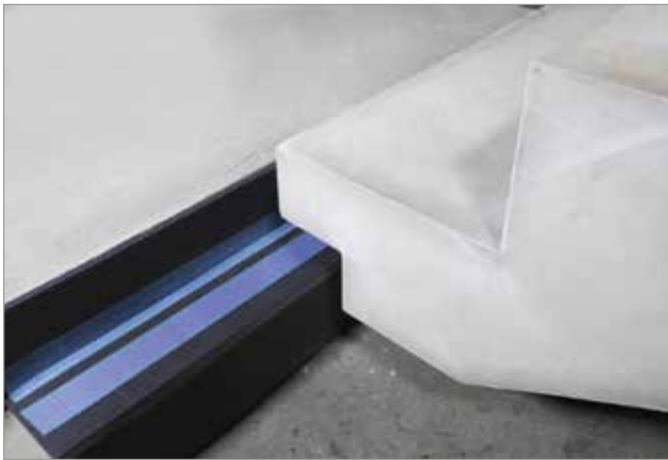
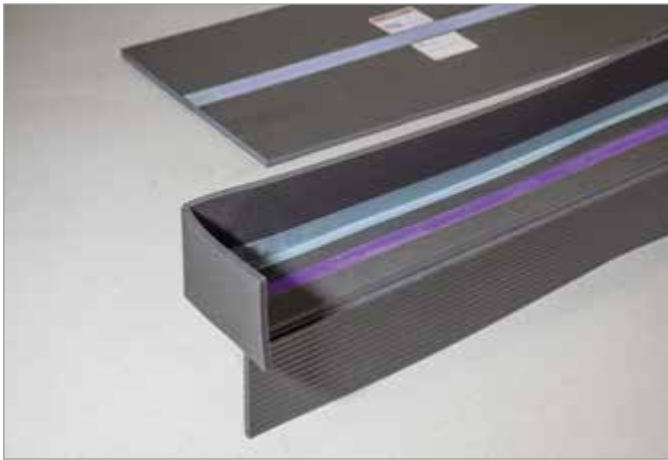

Apoyo para muro de forjado/losa Egcodist

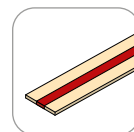
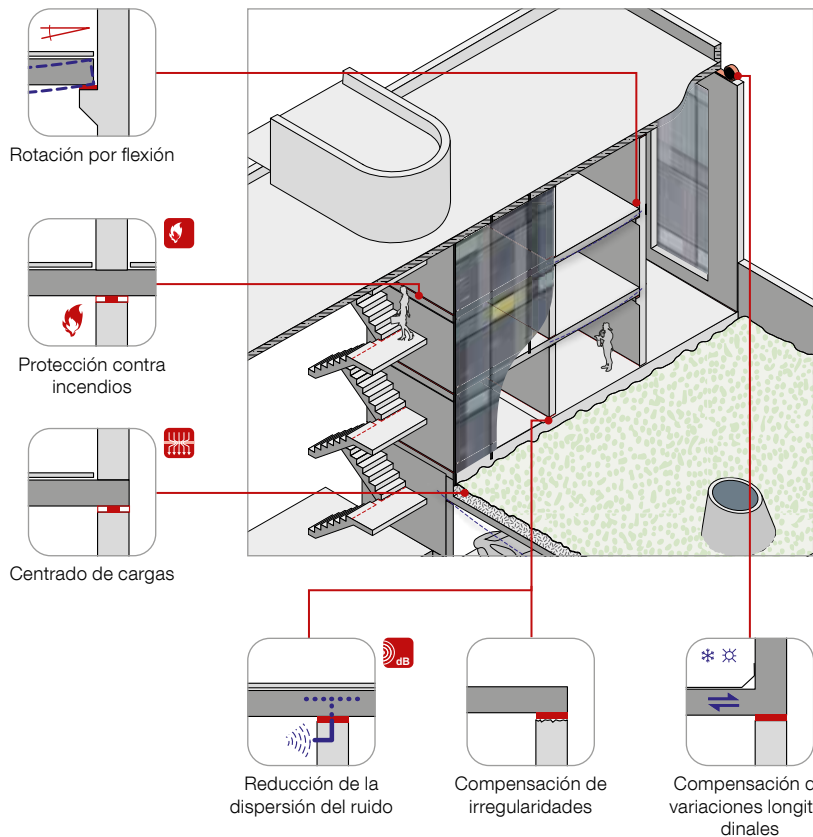

Apoyo de deformación Egcodist R90

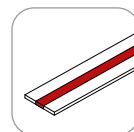

Apoyo de deformación Egcodist

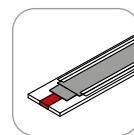

Apoyo deslizante Egcodist



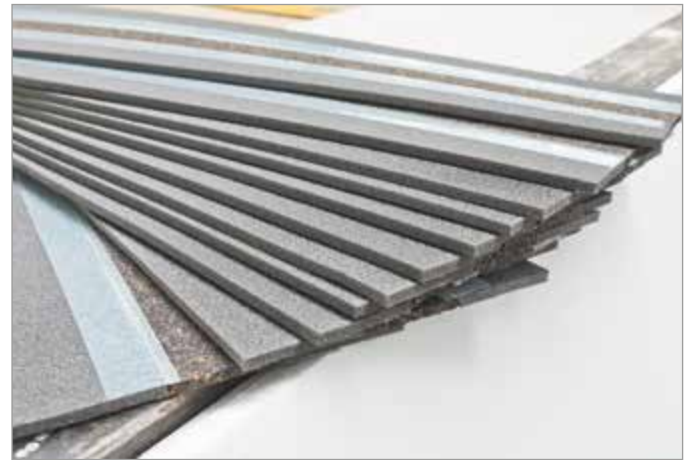

Panel de desacoplamiento Egcovoid®

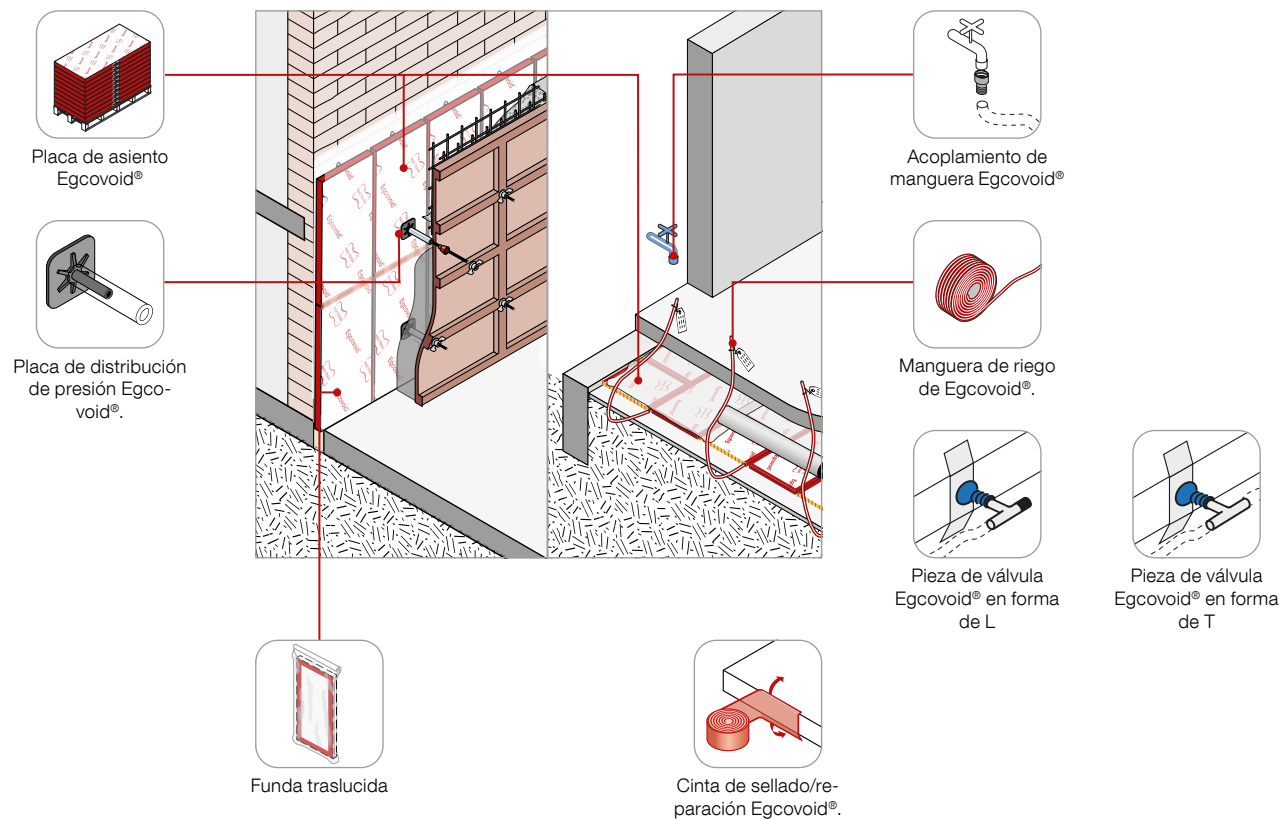

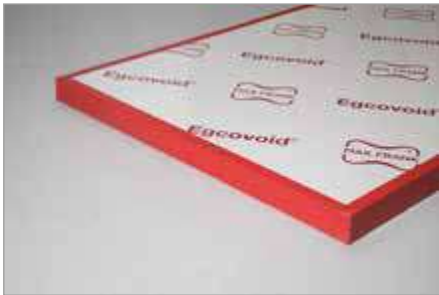







MAX FRANK Group

Local branch:

Max Frank Tecnologías para la Construcción, SL

Calle de la Marina 148-150 ent. 3a

08013 Barcelona

Spain

www.maxfrank.com

